



Hello Again

Quick Start Guide

Welcome to your Aqua mini & Aqua Pro

Overview what's in the box



Aqua Pro ¹

Super bracket - Part A ¹

Super bracket - Part B ¹

Super bracket - Part C ¹

Super bracket - Part D ¹



Aqua mini ¹

Super bracket - Part A ¹

Super bracket - Part B ¹

Super bracket - Part C ¹

Super bracket - Part D ¹

Accessories

Power adapter ¹

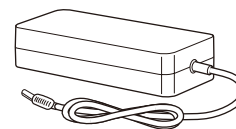

AC power cord ¹



2.0 Hex key ¹



3.0 Hex key ¹

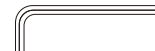

Bracket screws ⁴
(Stainless steel)



Bracket screws ²
(Stainless steel)



Bracket screws ²
(Plastic)



Hanging kits ¹
(Optional)

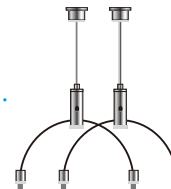

Lighting Specification



AQUA MINI

AQUA PRO

| | | |
|-----------------------|----------------------------------|----------------------------------|
| Item No. | G3-AM | G3-AP |
| Power | 60W | 120W |
| LED Quantity | 20pcs High Intensity | 42pcs High Intensity |
| LED Brand | 3W Bridgelux / Epistar LEDs | 3W Bridgelux / Epistar LEDs |
| Light Weight | 1.0kg (2.2pound) | 2.0kg (4.4pound) |
| Shipping Weight | 2.0kg (4.4pound) | 3.5kg (7.7pound) |
| Size | 140X140X46mm (5.5"x5.5"x1.8") | 200X200X50mm (7.8"x7.8"x1.9") |
| Packing | 310x180x70mm (12"x7.0"x2.8") | 430x230x70mm (17"x9.0"x2.8") |
| Universal Input Range | AC80-240V, 2.0A | AC80-240V, 2.0A |
| Lighting Cover | Suit For Min: 240mm ~ Max: 600mm | Suit For Min: 400mm ~ Max: 900mm |
| PSU Certification | UL, CE, Rosh, PSE, SAA etc. | UL, CE, Rosh, PSE, SAA etc. |

Getting Started

Congratulations on purchasing your Aqua mini & Aqua Pro. Read this guide to get started to installing your lighting.

Super Bracket

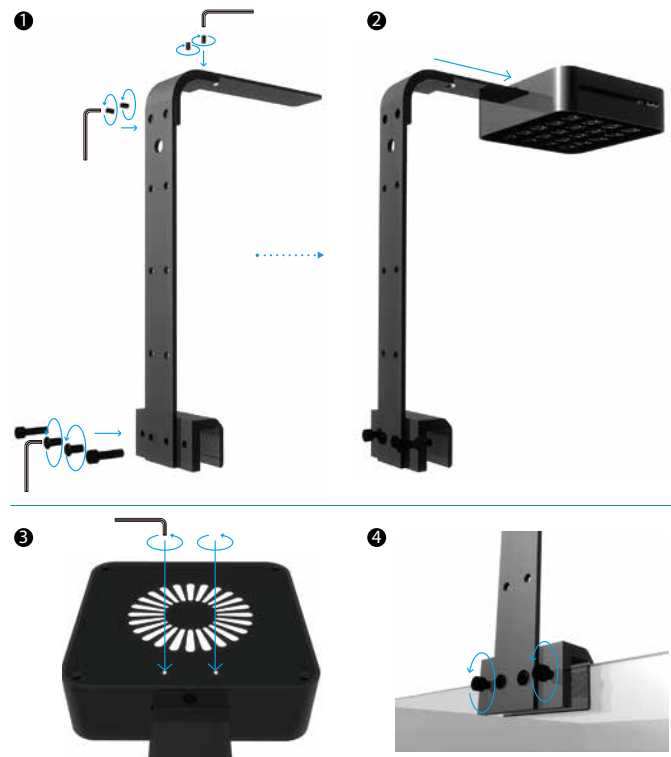

Hanging Kits

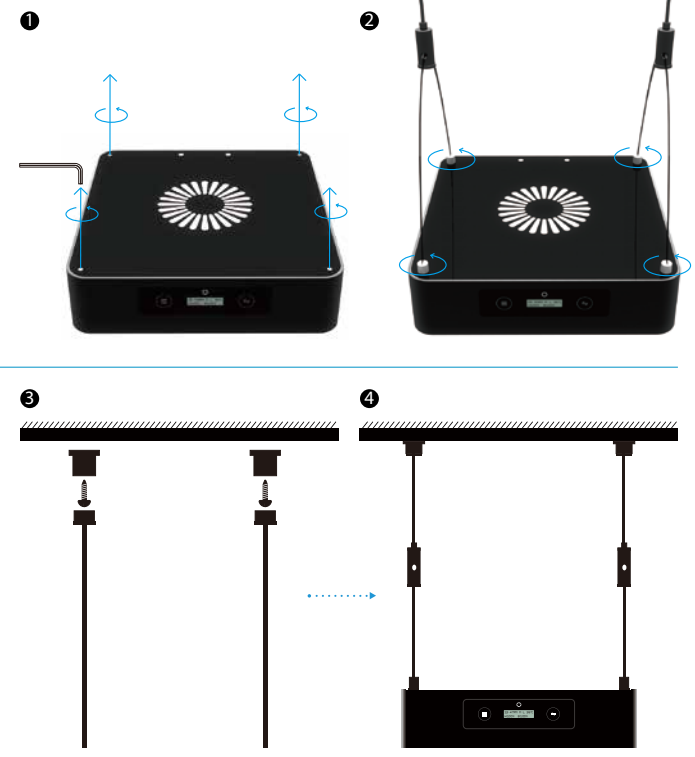

Mount Specification

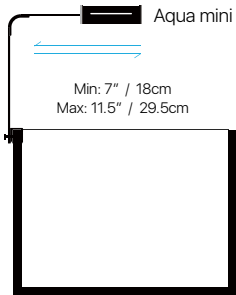

Side Scalable Range

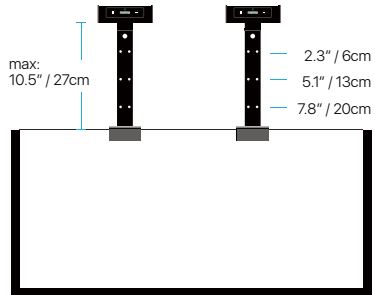

Up and Down Scalable Range

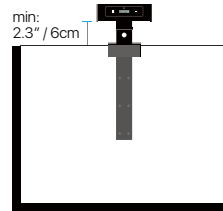

Lowest Height

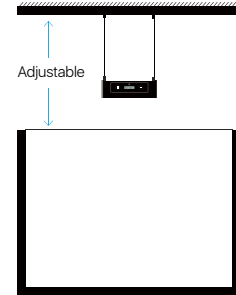

Hanging Kits (optional)

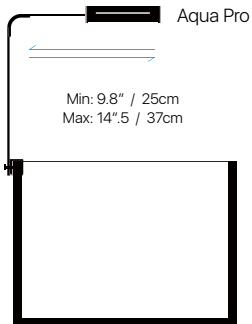

Side Scalable Range

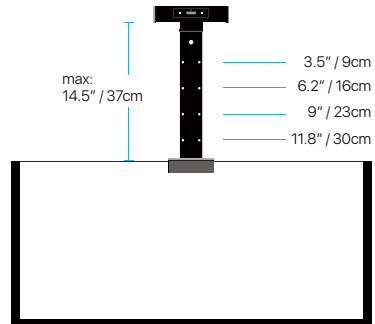

Up and Down Scalable Range

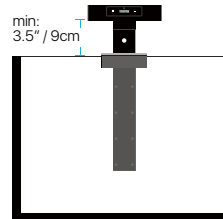

Lowest Height

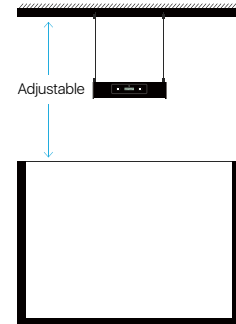

Hanging Kits (optional)

Aqua mini Performance

Marine Version

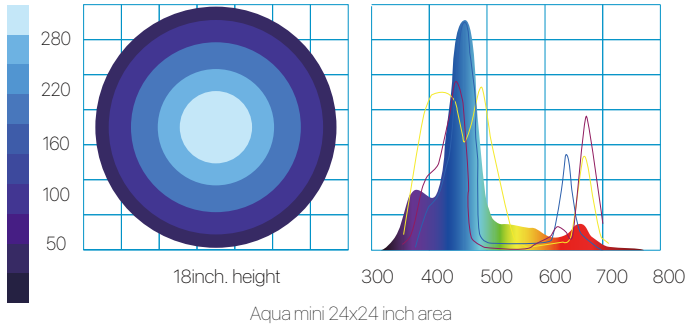

Planted Version

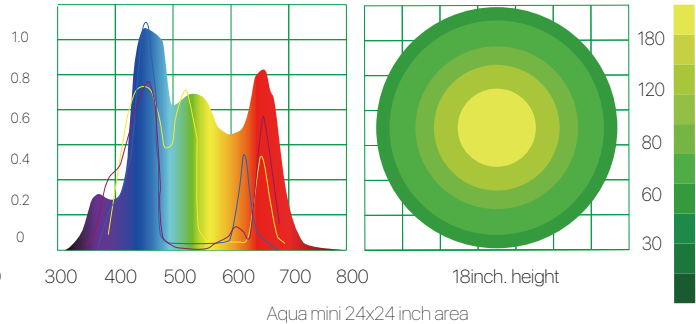

- 7pcs - Cool White - (12000~16000K) Channel A - White
- 7pcs - Royal Blue - (450~455nm) Channel B - Blue
- 1pc - Blue - (470~475nm) Channel C - Special
- 1pc - Violet - (410~415nm) Channel C - Special
- 1pc - UV - (380~395nm) Channel C - Special
- 1pc - Warm White - (3000~3500K) Channel C - Special
- 1pc - Deep Red - (660~665nm) Channel C - Special
- 1pc - Green - (510~520nm) Channel C - Special



- 7pcs - White - (6000~6500K) Channel A - White
- 7pcs - Cool White - (12000~16000K) Channel B - Blue
- 1pc - Deep Blue - (470~475nm) Channel C - Special
- 1pc - Violet - (410~415nm) Channel C - Special
- 1pc - UV - (380~395nm) Channel C - Special
- 1pc - Warm White - (3000~3500K) Channel C - Special
- 1pc - Deep Red - (660~665nm) Channel C - Special
- 1pc - Green - (510~520nm) Channel C - Special

Aqua Pro Performance

Marine Version

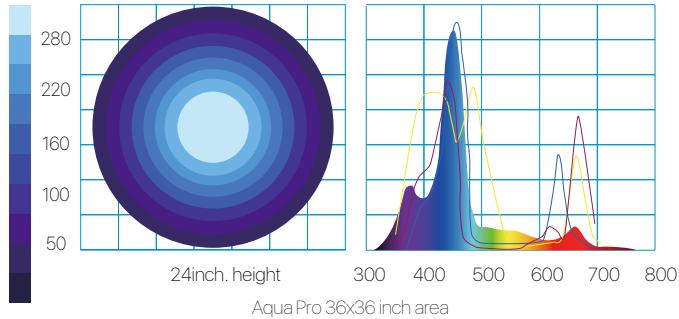

Planted Version

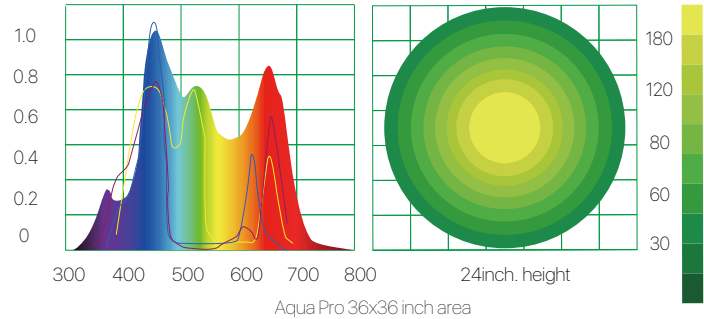

- 14pcs - Cool White - (12000~16000K) Channel A - White
- 14pcs - Royal Blue - (450~455nm) Channel B - Blue
- 6pcs - Blue - (470~475nm) Channel C - Special
- 2pcs - Violet - (410~415nm) Channel C - Special
- 2pcs - UV - (380~395nm) Channel C - Special
- 2pcs - Warm White - (3000~3500K) Channel C - Special
- 1pc - Deep Red - (660~665nm) Channel C - Special
- 1pc - Green - (510~520nm) Channel C - Special



- 14pcs - White - (6000~6500K) Channel A - White
- 14pcs - Cool White - (12000~16000K) Channel B - Blue
- 4pcs - Blue - (470~475nm) Channel C - Special
- 2pcs - Violet - (410~415nm) Channel C - Special
- 2pcs - UV (380~395nm) Channel C - Special
- 2pcs - Warm White - (3000~3500K) Channel C - Special
- 2pcs - Deep Red - (660~665nm) Channel C - Special
- 2pcs - Green - (510~520nm) Channel C - Special

Smart Control System

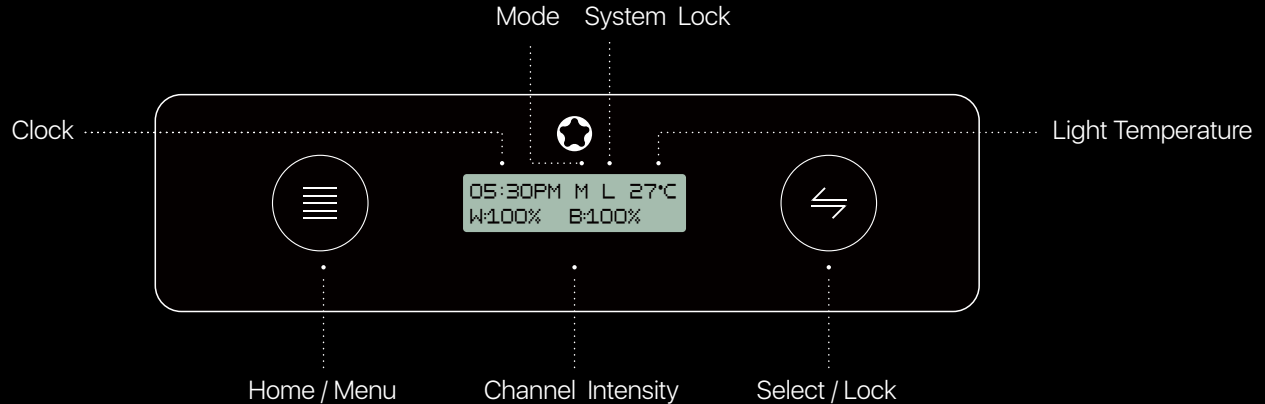

Home / Menu - Browse menu.

Special Function 1 : Hold on 3 second to return to the previous menu.

Special Function 2 : Hold on 3 second under the screen locked to quickly switch the "Auto mode" and "Manual mode".



Select / Adjust - Enter the sub-menu to adjust the parameters.

Special Function 1 : Hold on 3 second to unlock system.

Special Function 2 : Hold on 3 second to lock system.



Setting Up Your Aqua mini & Pro now.

| | Auto Mode | | Manual Mode | |
|--|---|---|---|---|
| <div style="border: 1px solid black; padding: 5px; text-align: center;"> Systems Loading iMOS 3.0M </div> <p style="text-align: center;">Boot screen</p> | <div style="border: 1px solid black; padding: 5px; text-align: center;"> 05:30PM A L 33°C W:060% B:060% </div> <p style="text-align: center;">Home screen 1</p> | <div style="border: 1px solid black; padding: 5px; text-align: center;"> 05:30PM A LT 33°C S:030% </div> <p style="text-align: center;">Home screen 2</p> | <div style="border: 1px solid black; padding: 5px; text-align: center;"> 05:30PM M L 33°C W:100% B:100% </div> <p style="text-align: center;">Home screen 1</p> | <div style="border: 1px solid black; padding: 5px; text-align: center;"> 05:30PM M LT 33°C S:100% </div> <p style="text-align: center;">Home screen 2</p> |







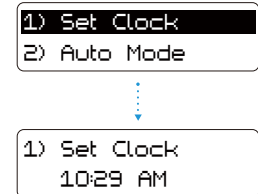





Note: "A" = Auto Mode, "M" = Manual Mode, "L" = Locked, "LT" = Lightning ON.

1) Set Clock

1. Hold Select/Lock for 3 seconds to unlock controller
2. Press Home/Menu to enter main menu
3. Press Home/Menu to toggle through options
4. Press Select/Lock to select 1) Set Clock menu
5. Press Select/Lock to adjust Time.
6. Press Home/Menu to toggle through options
7. Press Home/Menu to return to main menu



2) Auto Mode - Set LEDs (e.g: Set White Channel)





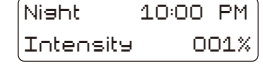
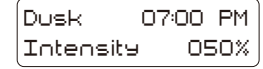
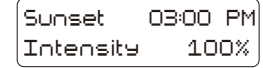
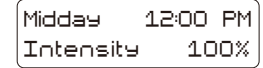
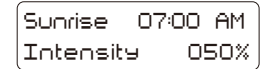
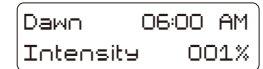

1. Hold  Select/Lock for 3 seconds to unlock controller
2. Press  Home/Menu to enter main menu
3. Press  Home/Menu to toggle through options
4. Press  Select/Lock to select 2) Auto Mode menu
5. Press  Select/Lock to select Set White menu
6. Press  Select/Lock to adjust DawnTime.
7. Press  Home/Menu to toggle through options
8. Press  Home/Menu to select Intensity
9. Press  Select/Lock to adjust Intensity.
10. Press  Home/Menu to toggle through options
11. Press  Home/Menu to move to next setpoint
12. Repeat Steps 5-9 for Sunrise, Midday, Sunset, Dusk and Night
13. Press  Home/Menu to return to main menu

Auto Mode (Set Blue & Special Channel)

Set the Blue Channel and Special Channel are same as the White Channel operate step.

















3) Manual Mode

1. Press  Select/Lock to select 3) Manual Mode menu
2. Press  Home/Menu to adjust Enable Manual Mode > Yes/No
3. Press  Select/Lock to enter the channel selection list
4. Press  Home/Menu to select the White, Blue, Special Channel
5. Press  Select/Lock to adjust Intensity for each channel
6. Press  Home/Menu to return to main menu

4) Lightning

The advanced settings allow you to control the time period storms will occur in a 24 hour period, the number of storms during this set time and the frequency at which a storm period is activated.

1. Hold  Select/Lock for 3 seconds to unlock controller
2. Press  Home/Menu to enter main menu
3. Press  Home/Menu to toggle through options
4. Press  Select/Lock to select 5) Set Lightning menu
5. Press  Home/Menu to set Start/End Hour
6. Press  Select/Lock to adjust Start/End Hour. Press  Home/Menu to toggle through options
7. Press  Home/Menu to return to previous menu
8. Press  Select/Lock to adjust Enable Lightning > Yes/No
9. Press  Home/Menu to set Per Day and Frequency
10. Press  Select/Lock to adjust Per Day
11. Press  Home/Menu to set Frequency
12. Press  Select/Lock to adjust Frequency
13. Press  Home/Menu to return to main menu

| |
|----------------|
| 3) Manual Mode |
| 4) Lightning |



| |
|----------------|
| 3) Manual Mode |
| Enable YES/NO |



| | |
|-------|------|
| White | 100% |
| Blue | 100% |

| | |
|---------|------|
| Special | 100% |
|---------|------|

| |
|----------------|
| 3) Manual Mode |
| 4) Lightning |





| |
|---------------|
| 4) Lightning |
| Enable YES/NO |



| | |
|------------|------|
| Start Hour | 00AM |
| End Hour | 00PM |

| | |
|-----------|----|
| Per Day | 00 |
| Frequency | 00 |



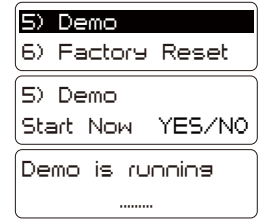

5) Demo

1. Press  Home/Menu button to enter main menu
2. Press  Home/Menu button to select 5) DEMO
3. Press  Select/Lock button to select YES

Note: The DEMO will show all your settings in 1 minute



6) Factory Reset

1. Press  Home/Menu button to enter main menu
2. Press  Home/Menu button to select Factory Reset
3. Press  Select/Lock button to select YES
4. Press  Home/Menu button to set Factory Reset

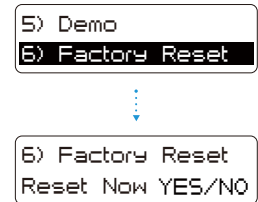

The Control system will gradually ramp the intensity of LED between set points.
The graph below outlines how the LEDs will ramp up and down between settings.

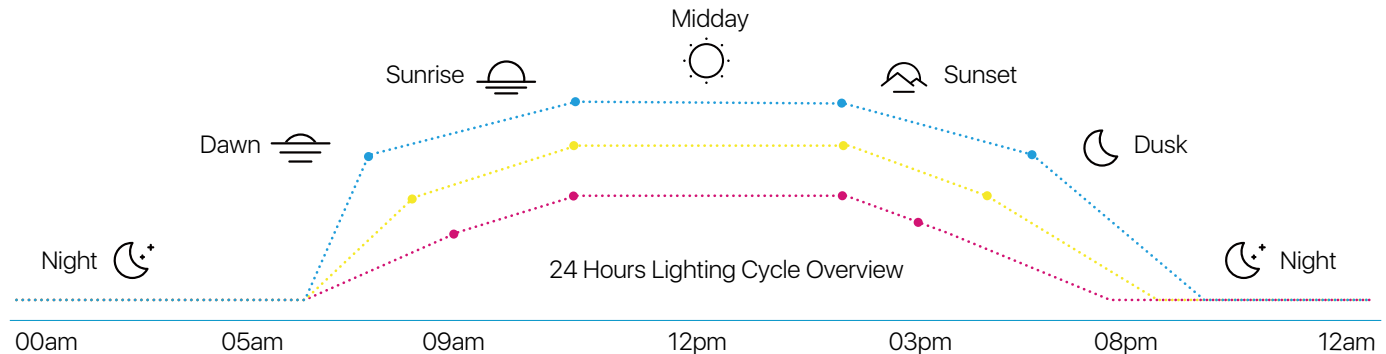

The sample settings below can be used to create different color spectrums in your tank.

| 10K White | | | | | | |
|-------------------|-------------|---------------|-----------------|----------------|---------------|--------------|
| | Dawn | Sunrise | Midday | Sunset | Dusk | Night |
| White Channel A | 0% @ 6:00AM | 80% @ 8:00 AM | 100% @ 12:00 PM | 100% @ 3:00 PM | 80% @ 6:00 PM | 0% @ 8:00 PM |
| Blue Channel B | 1% @ 6:00AM | 25% @ 7:00 AM | 50% @ 10:00 PM | 50% @ 3:00 PM | 25% @ 6:00 PM | 1% @ 8:00 PM |
| Special Channel C | 0% @ 6:00AM | 50% @ 8:00 AM | 75% @ 12:00 PM | 75% @ 3:00 PM | 50% @ 6:00 PM | 0% @ 8:00 PM |

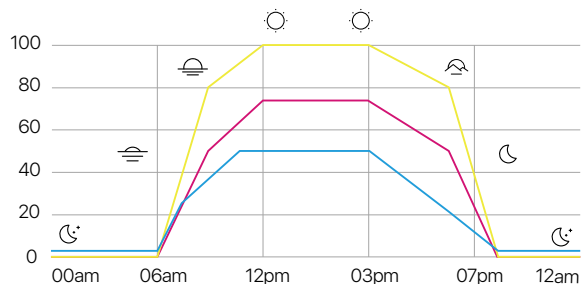

| 15K White & Blue | | | | | | |
|-------------------|-------------|---------------|-----------------|----------------|---------------|--------------|
| | Dawn | Sunrise | Midday | Sunset | Dusk | Night |
| White Channel A | 0% @ 6:00AM | 80% @ 8:00 AM | 100% @ 12:00 PM | 100% @ 3:00 PM | 80% @ 6:00 PM | 0% @ 8:00 PM |
| Blue Channel B | 1% @ 6:00AM | 80% @ 7:00 AM | 10% @ 10:00 PM | 100% @ 3:00 PM | 80% @ 6:00 PM | 1% @ 8:00 PM |
| Special Channel C | 0% @ 6:00AM | 50% @ 8:00 AM | 75% @ 12:00 PM | 75% @ 3:00 PM | 50% @ 6:00 PM | 0% @ 8:00 PM |

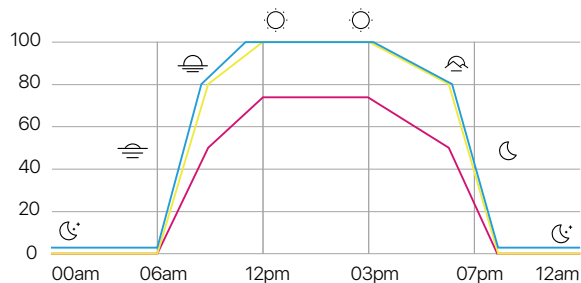

| 20K Heavy Blue | | | | | | |
|-------------------|-------------|---------------|----------------|---------------|---------------|--------------|
| | Dawn | Sunrise | Midday | Sunset | Dusk | Night |
| White Channel A | 0% @ 6:00AM | 25% @ 8:00 AM | 50% @ 12:00 PM | 50% @ 3:00 PM | 25% @ 6:00 PM | 0% @ 8:00 PM |
| Blue Channel B | 0% @ 6:00AM | 25% @ 7:00 AM | 50% @ 10:00 PM | 50% @ 3:00 PM | 25% @ 6:00 PM | 0% @ 8:00 PM |
| Special Channel C | 0% @ 6:00AM | 50% @ 8:00 AM | 75% @ 12:00 PM | 75% @ 3:00 PM | 50% @ 6:00 PM | 0% @ 8:00 PM |

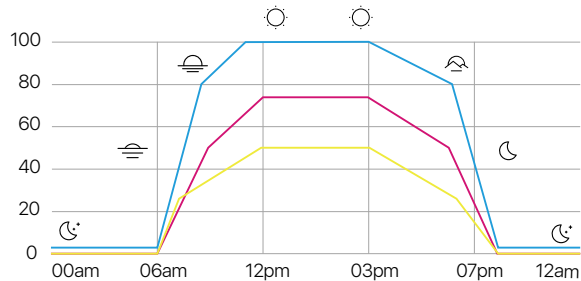

Information

WARNING: Never push objects of any kind into this product through the ventilation openings in the case. Doing so may be dangerous and damage your light.

Important Handling Information

NOTICE: Failure to follow these handling instructions could result in damage to your Aqua mini & Pro or other property.

Carrying your Aqua mini & Pro before you move your Aqua mini & Pro, shut it down and disconnect all cables and cords connected to it.

Using power cord Never force a connector into a port. Don't put the power cord into your tank when it connected.

When you Setup your Aqua mini & Pro please make sure that there are no loose items (such as paper, metal or other) that could accidentally get inside the Aqua mini & Pro through vent openings or get stuck inside a port.

Mount your power supply where it won't get wet. Include a "drip loop" - a tied loop of cord hanging down below the level of the electrical outlet. That way, if water happens to run down the cord from the tank, it will drip off onto the floor rather than into the outlet. Drip Loops should always be used to help prevent water from traveling along the cord and coming into contact with an electrical outlet. Drip loops must always be below the level of the outlet. If the plug or outlet does get wet, DO NOT TOUCH the cord.

Storing your Aqua mini & Pro If you are going to store your Aqua mini & Pro for an extended period of time, keep it in a cool location (ideally, 71° F or 22° C).When cleaning the outside of your Aqua mini & Pro, first shut down your Aqua mini & Pro and unplug the power cord. Then use a damp, soft, lint-free cloth to clean the lamp exterior. Avoid getting moisture in any openings. Do not spray liquid directly on the lamp. Do not use aerosol sprays, solvents, or abrasives that might damage the finish.

MicMol and the Environment

MicMol. recognizes its responsibility to minimize the environmental impact of its operations and products.



Warranty

MicMol warrants all MicMol products to be free from manufacturing defects for one year from the original purchase date when purchased through an authorized MicMol retailer. This warranty does not cover any damages caused by misuse, neglect, alterations or improper handling / transport / maintenance / installation. Physical damages are not covered by warranty. MicMol does not cover personal injury, personal loss, or other damages associated with the use of our products. In order to request warranty service, please email us at support@micmol.com. A purchase receipt is required for any warranty service. Products requiring warranty service must be returned to MicMol or authorized MicMol retailer. You are responsible for the cost of shipping a warranty claim to MicMol and any damages that may occur during transit. Once a returned product has been inspected, it will be repaired or exchanged at our discretion and returned to you. Thank you very much.





© 2012~2018 MicMol Limited. All rights reserved.

MicMol, the MicMol logo, Aqua mini, Aqua Pro, Aqua Air, Aqua CC, BloomBee are trademarks of MicMol registered.

MP003-1720-A Printed in China